

タキロン  
 中空形300A (溝カバー付き)  
 (デッキチュークA) Hひのき  
 300×3000 42枚  
 早急にお見積り願います。

14×3=42

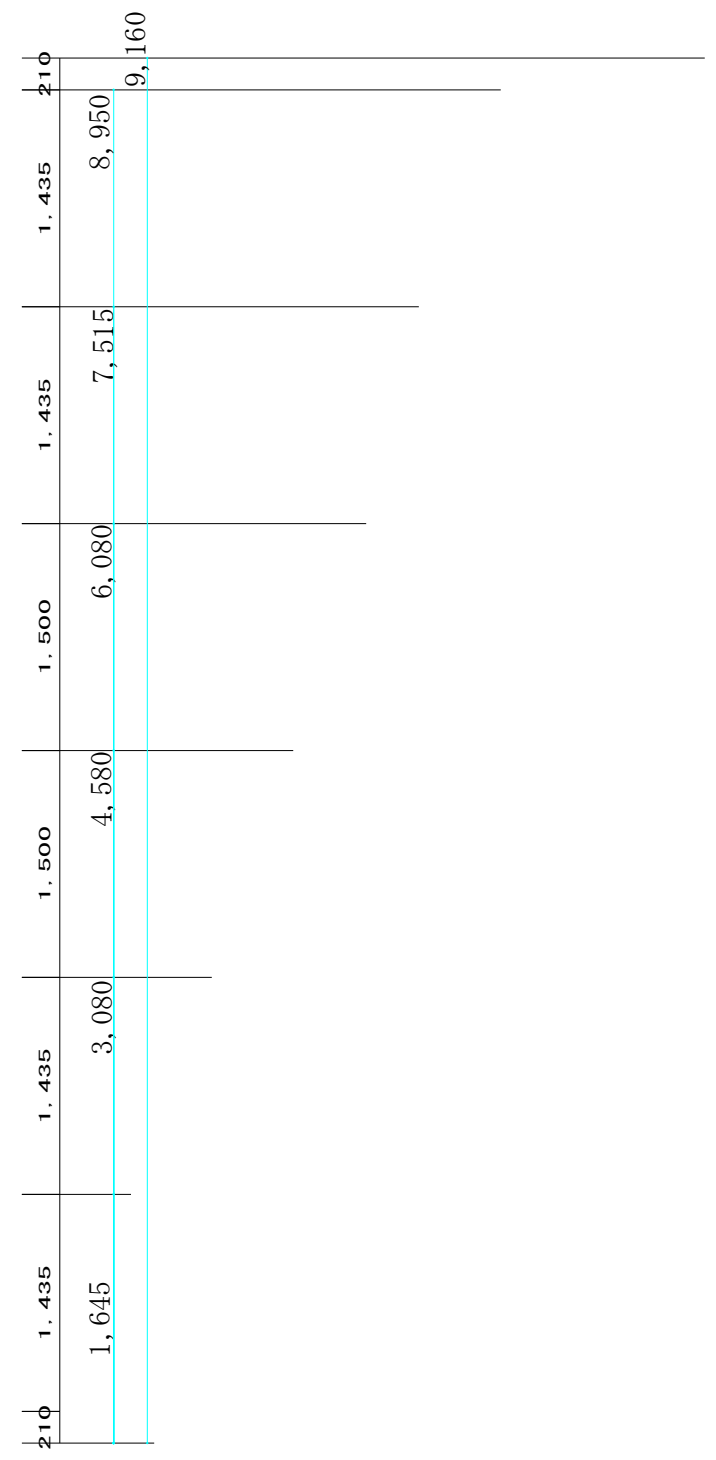

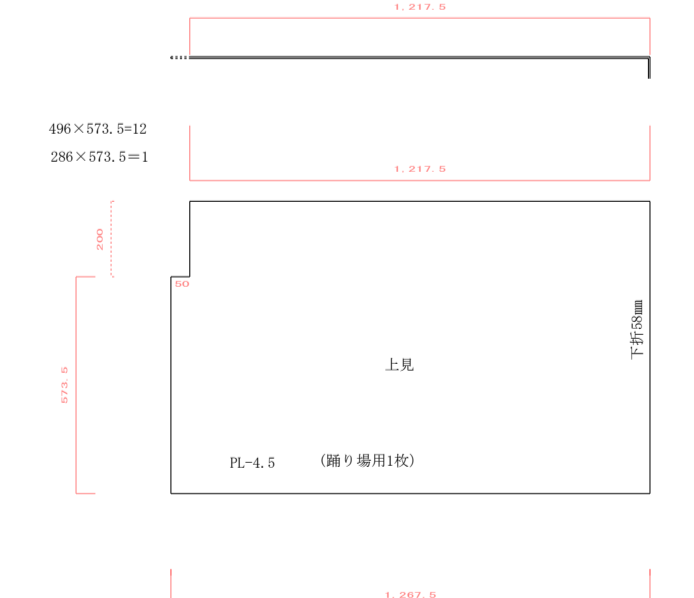

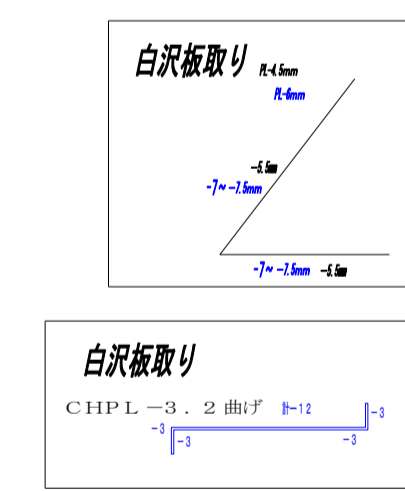
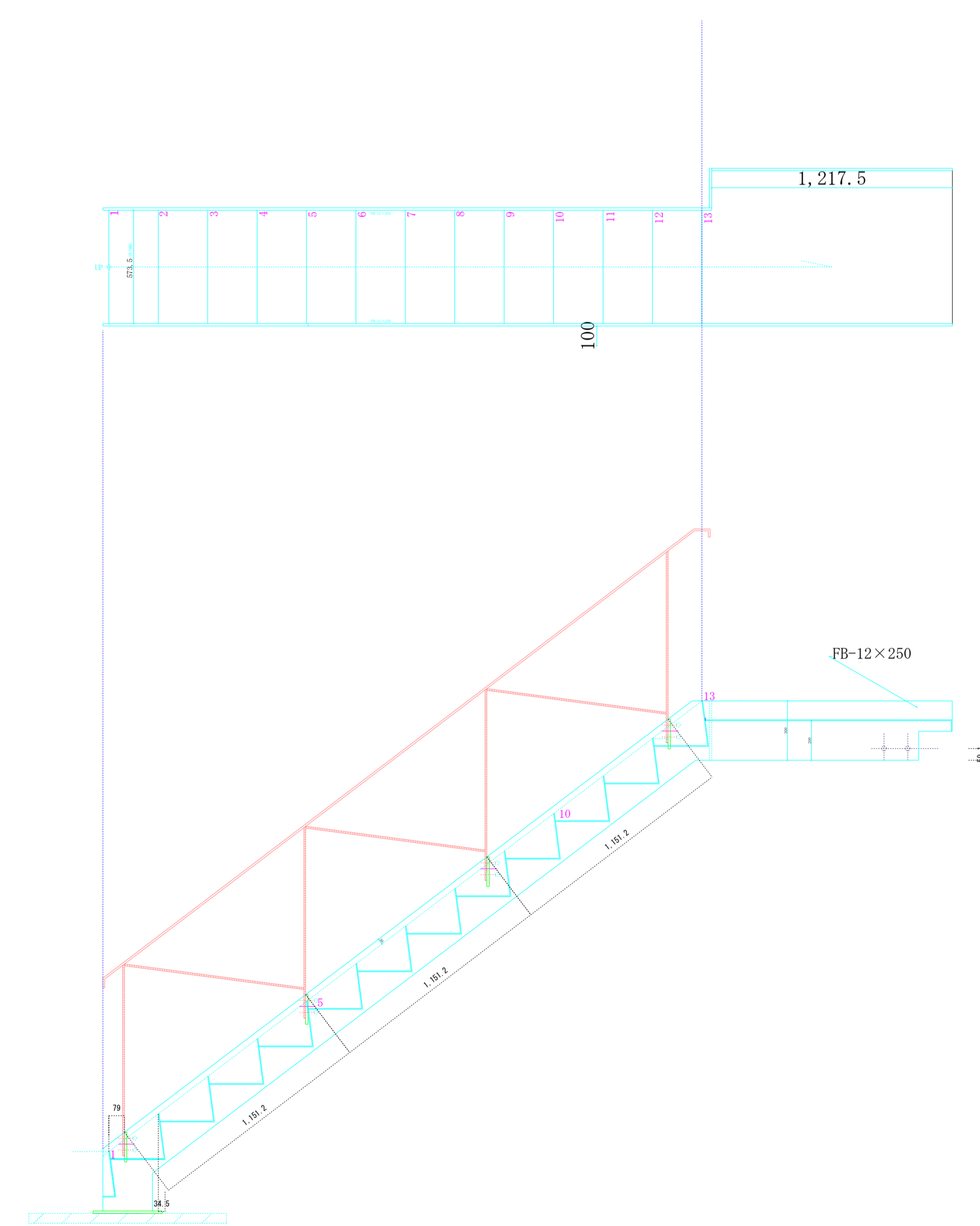
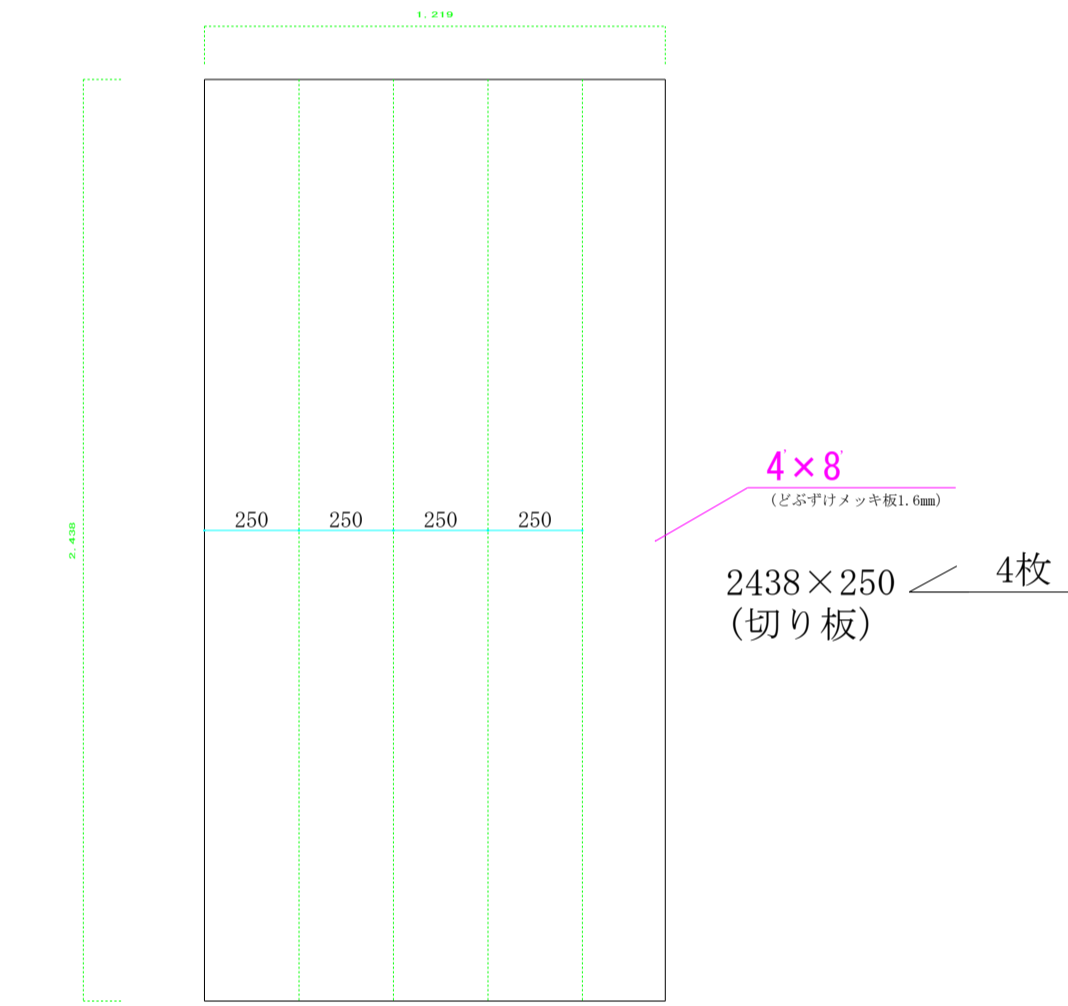
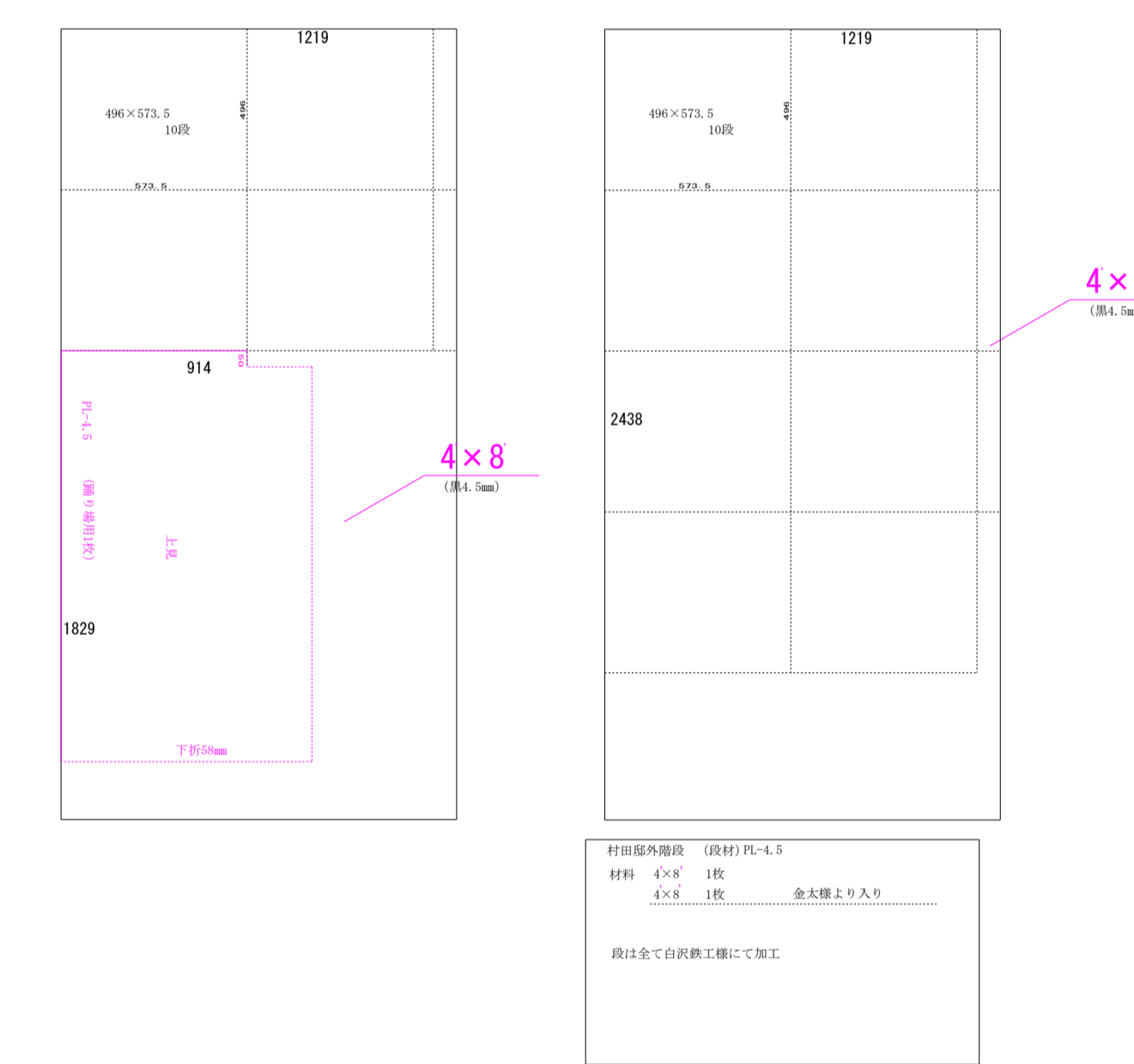
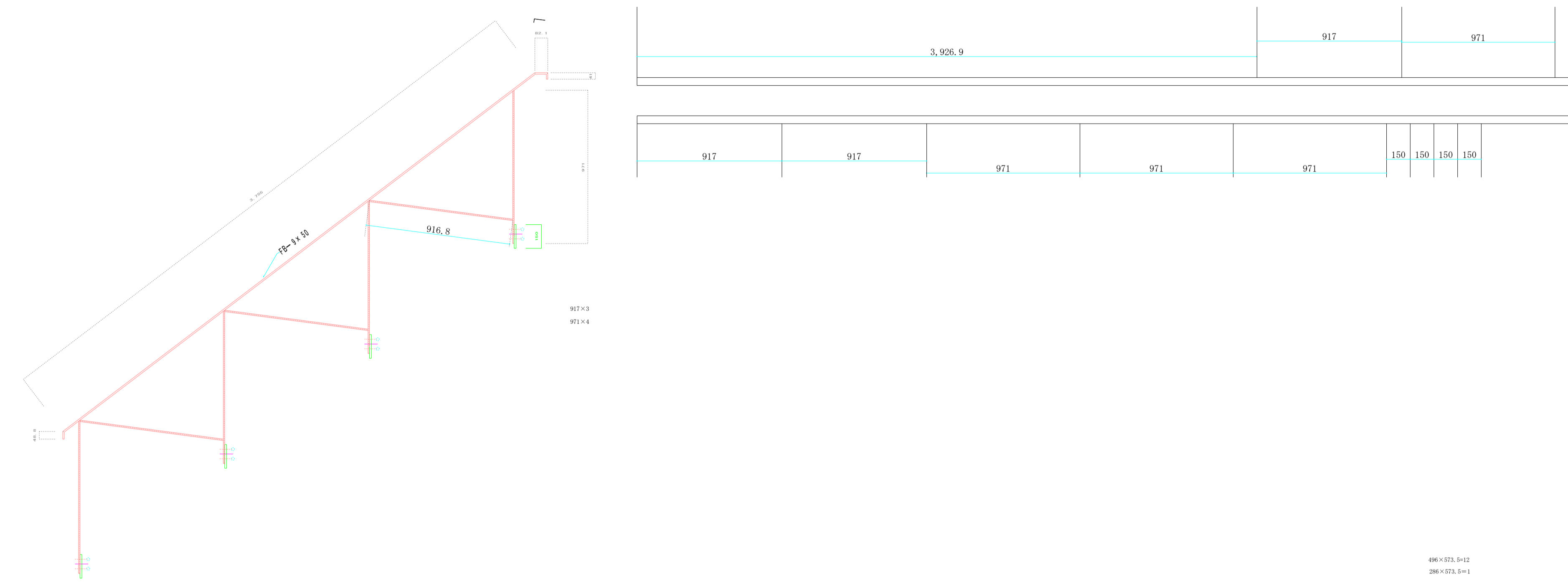
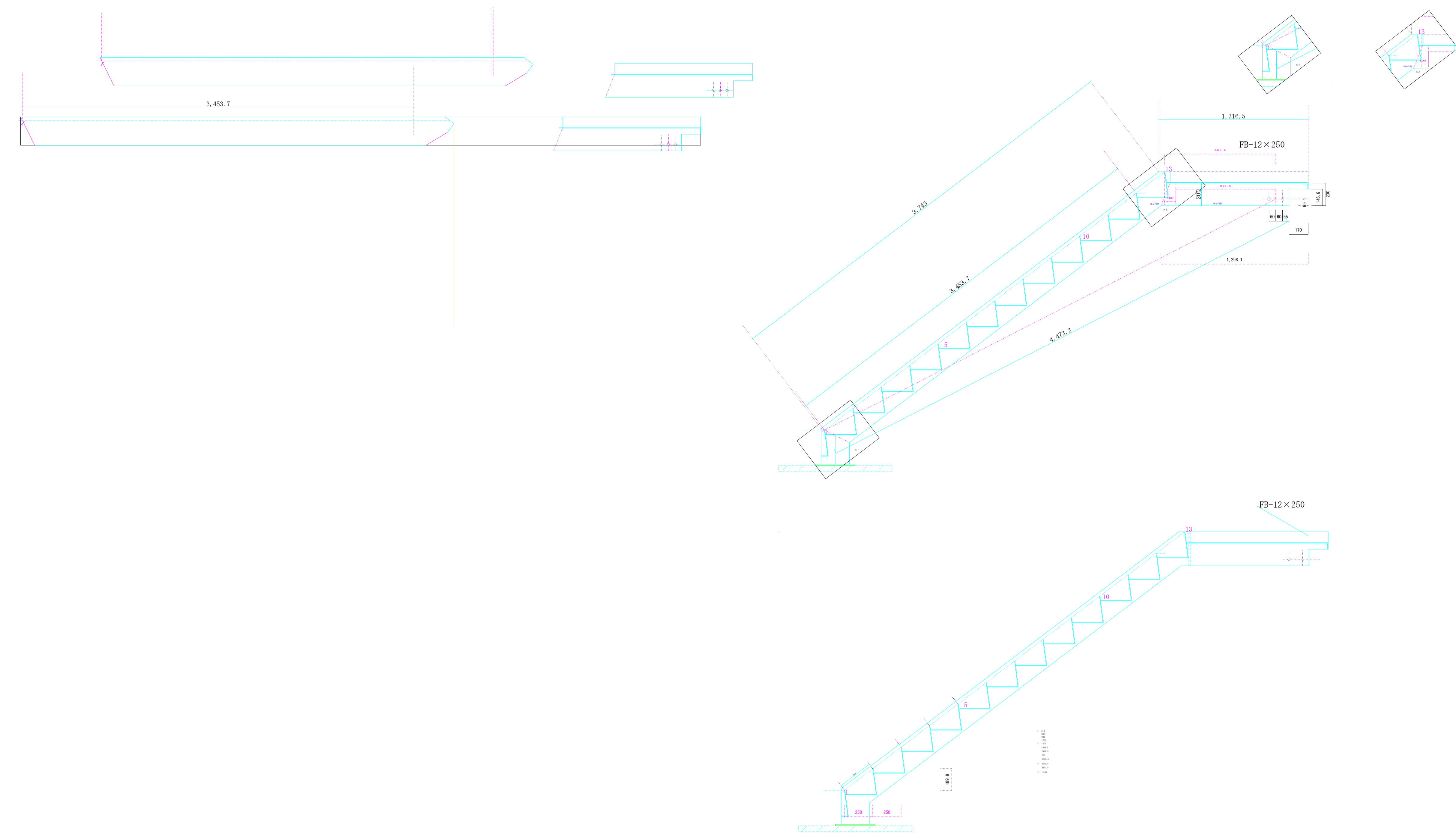
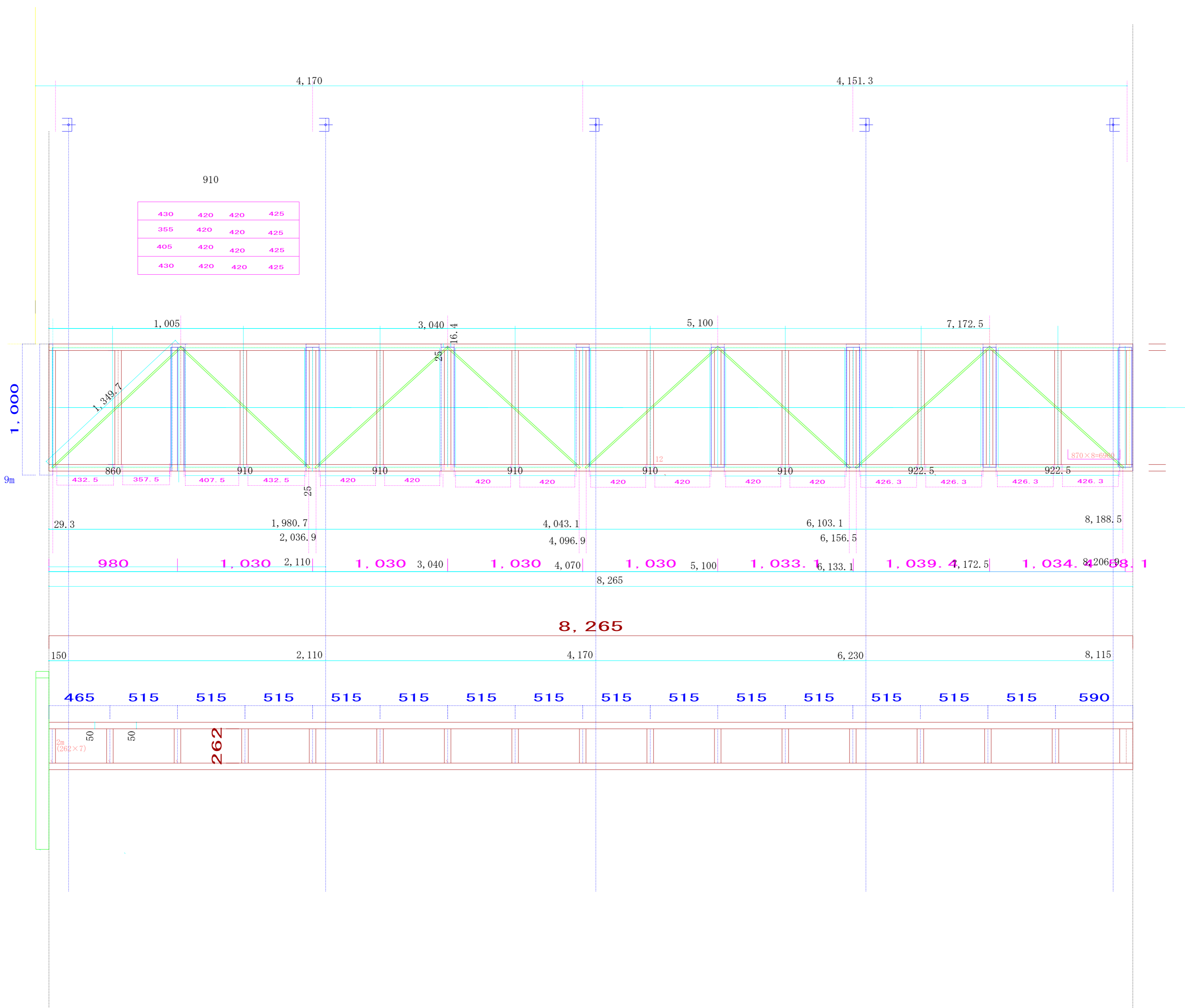

430	420	420	425
355	420	420	425
405	420	420	425
430	420	420	425

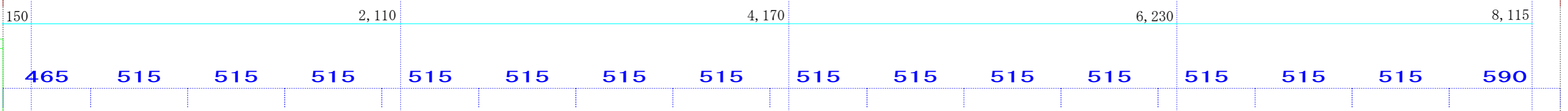
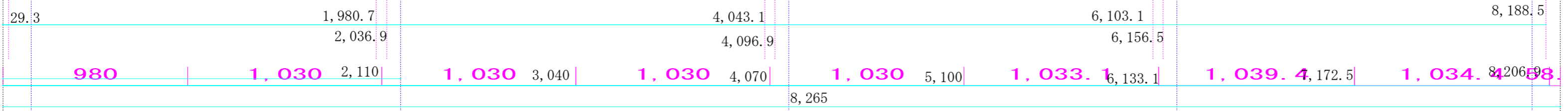
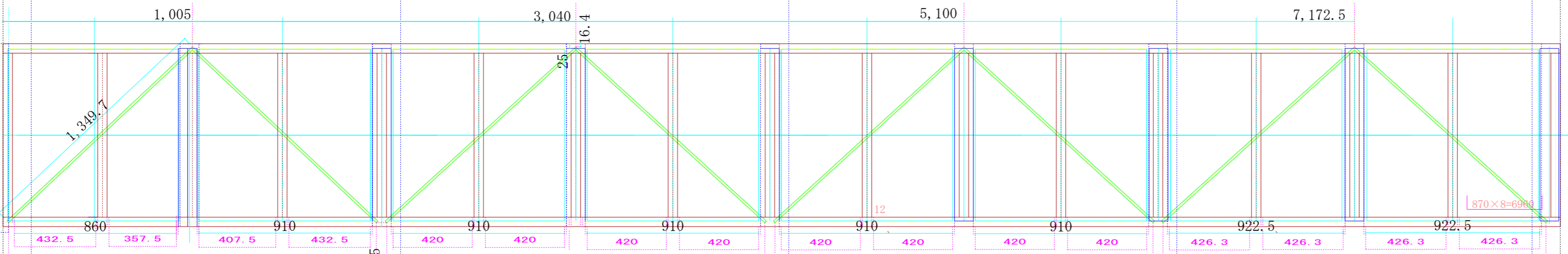

平面水平アンカープラン S=1/20

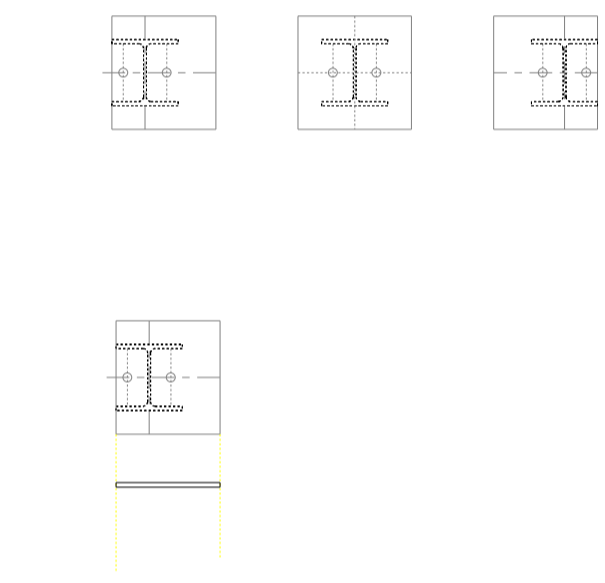
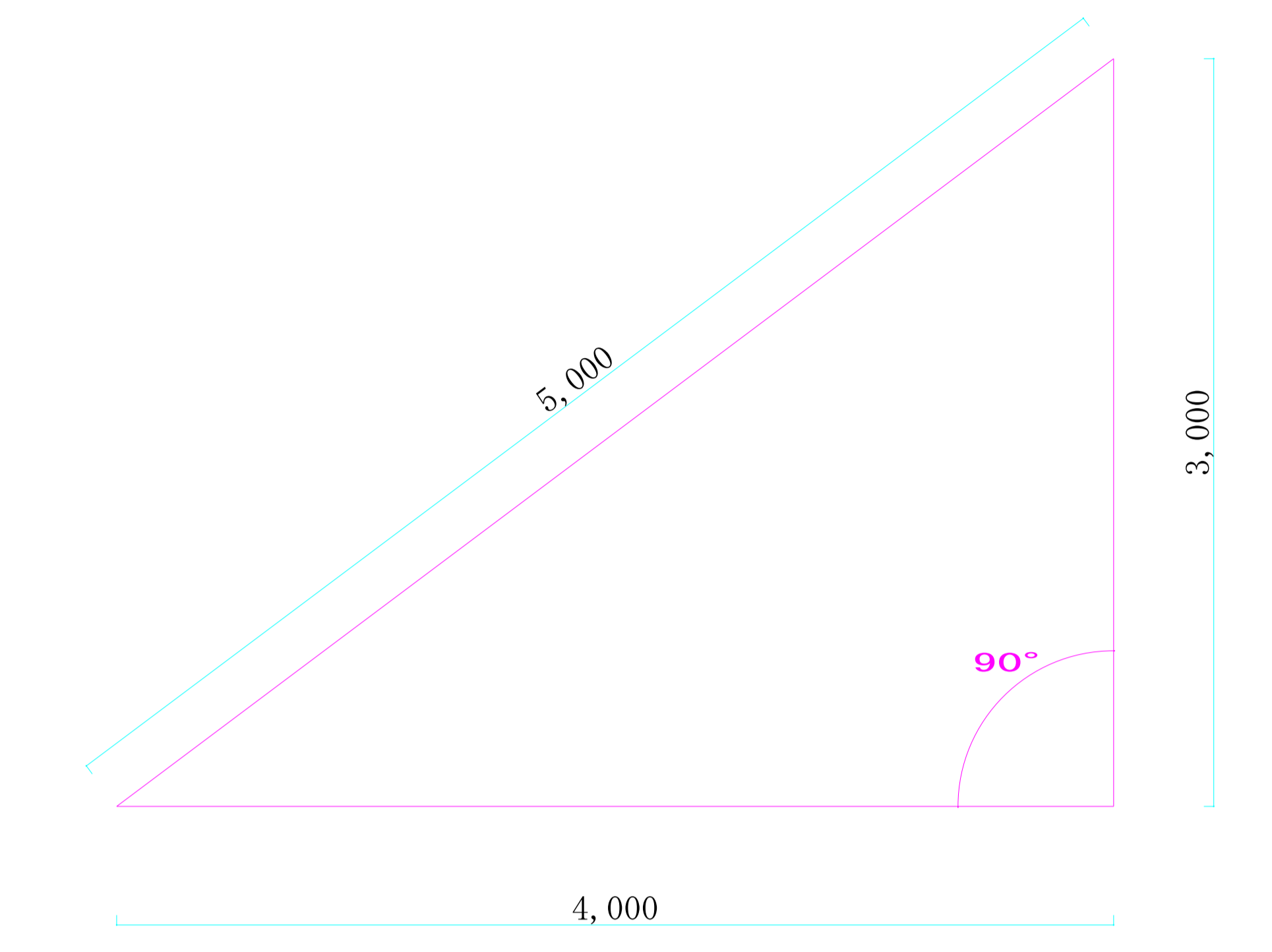
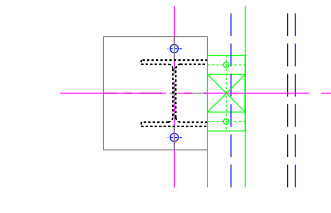
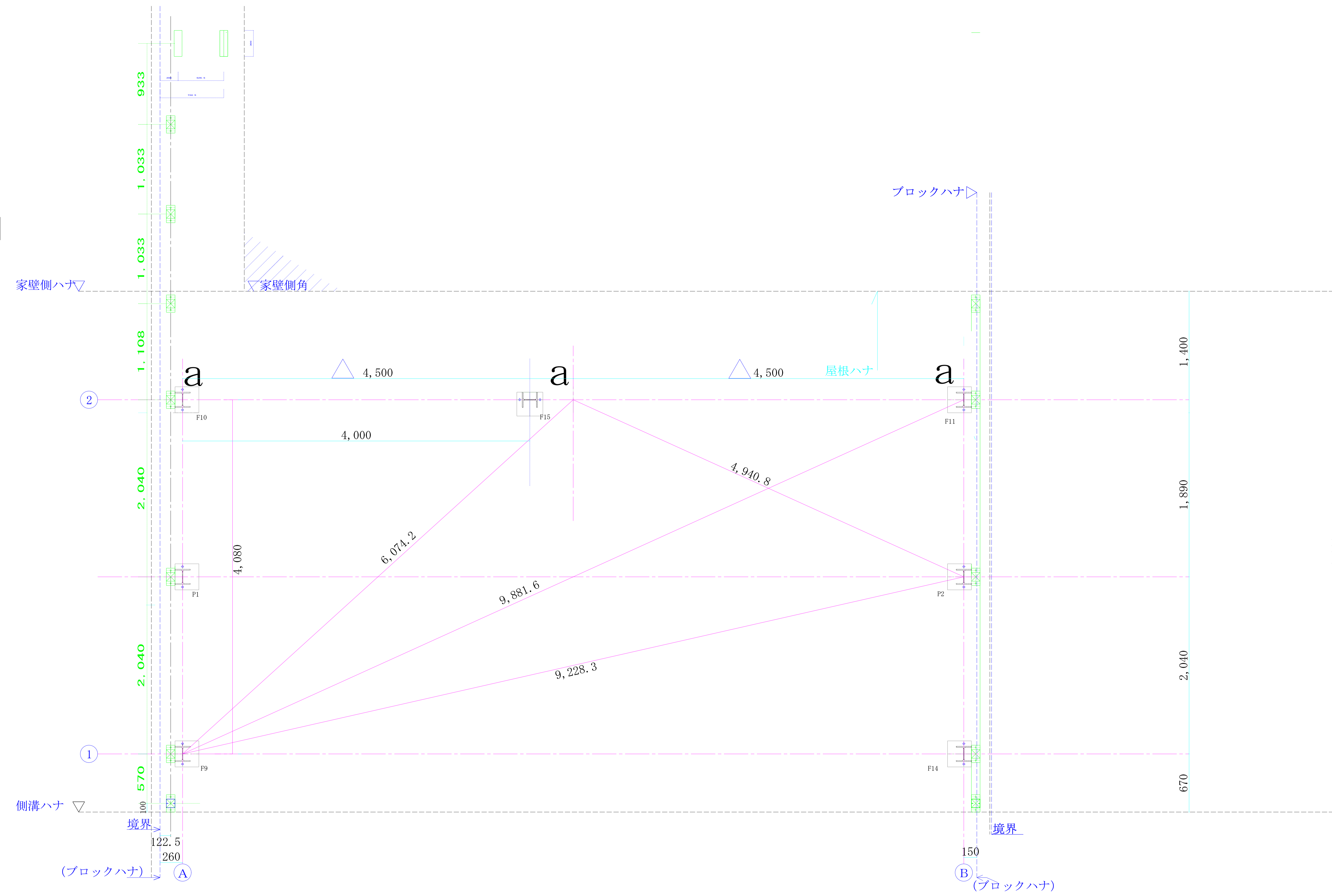

水平アンカープラン S=1/10 1F Lより175下がりアンカー鉄板天  
埋め込みアンカー a

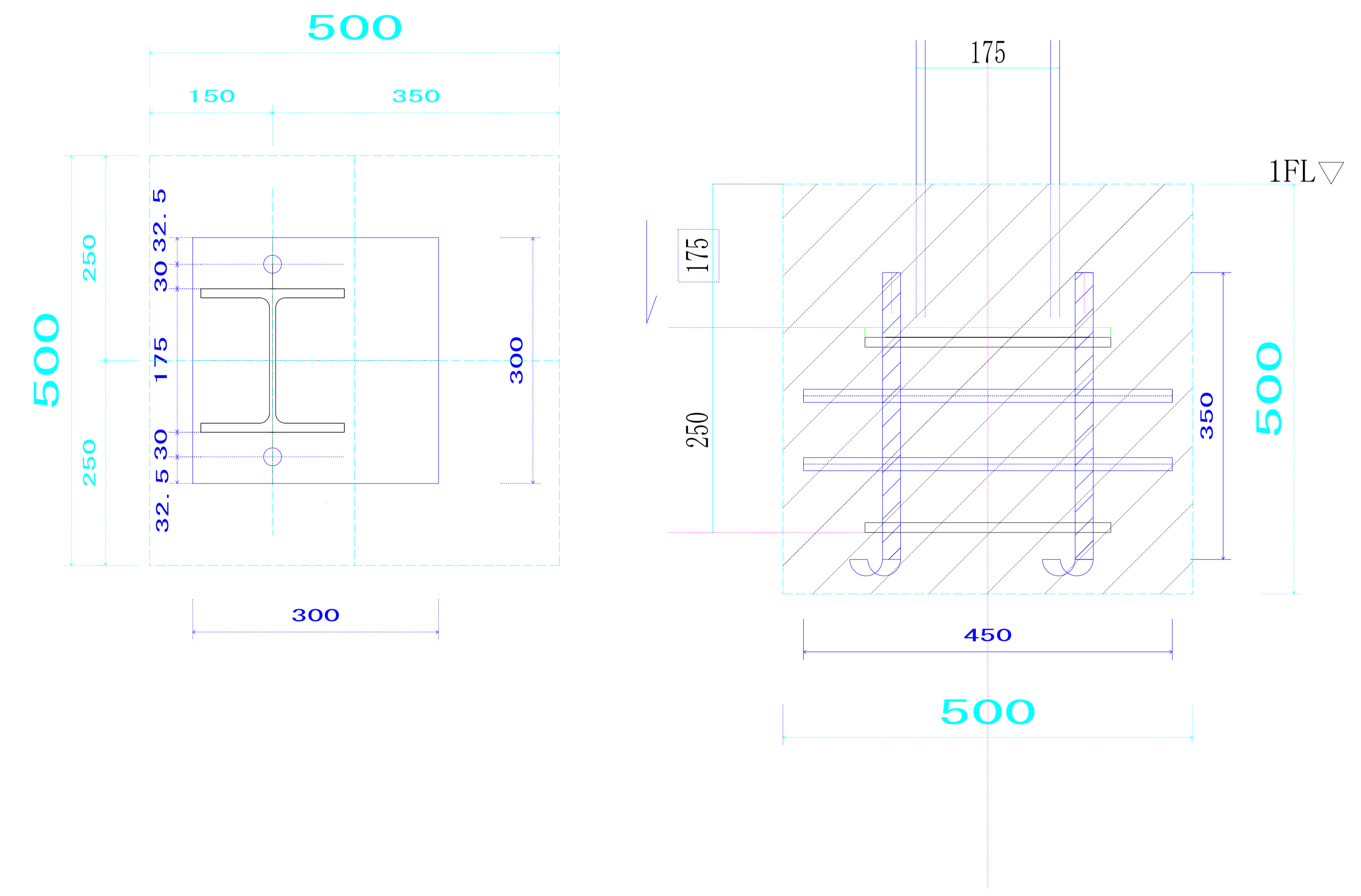

埋め込みアンカー用  
J型AB M22×415×130S:100 N×2 → 6本

A2柱基準（ハリ下2300くらいがベース下端）

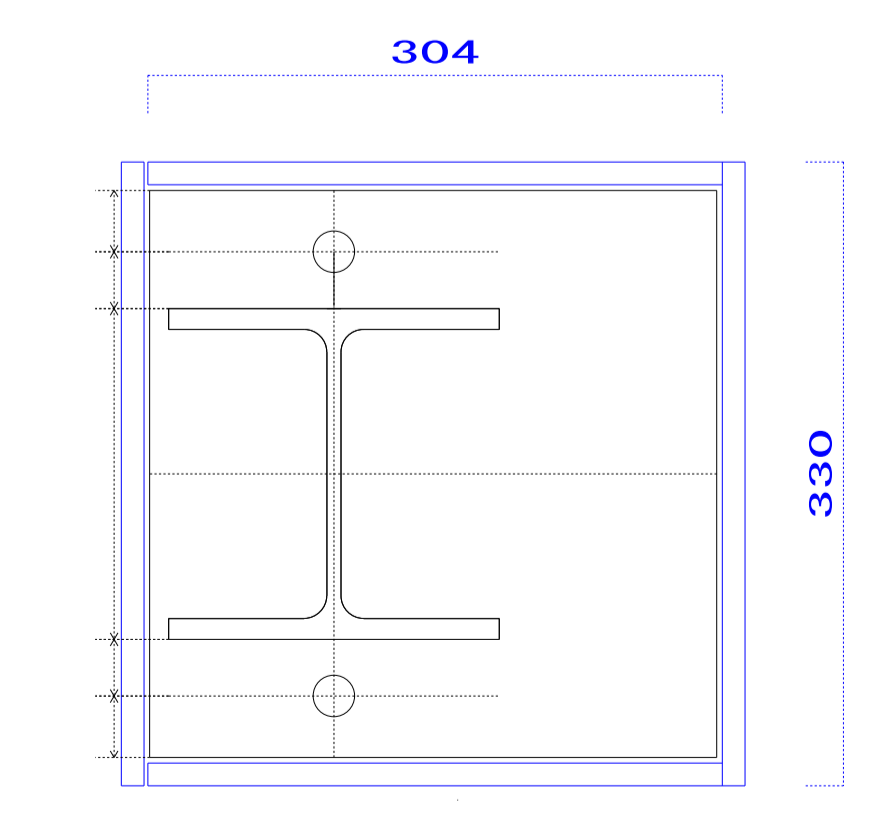
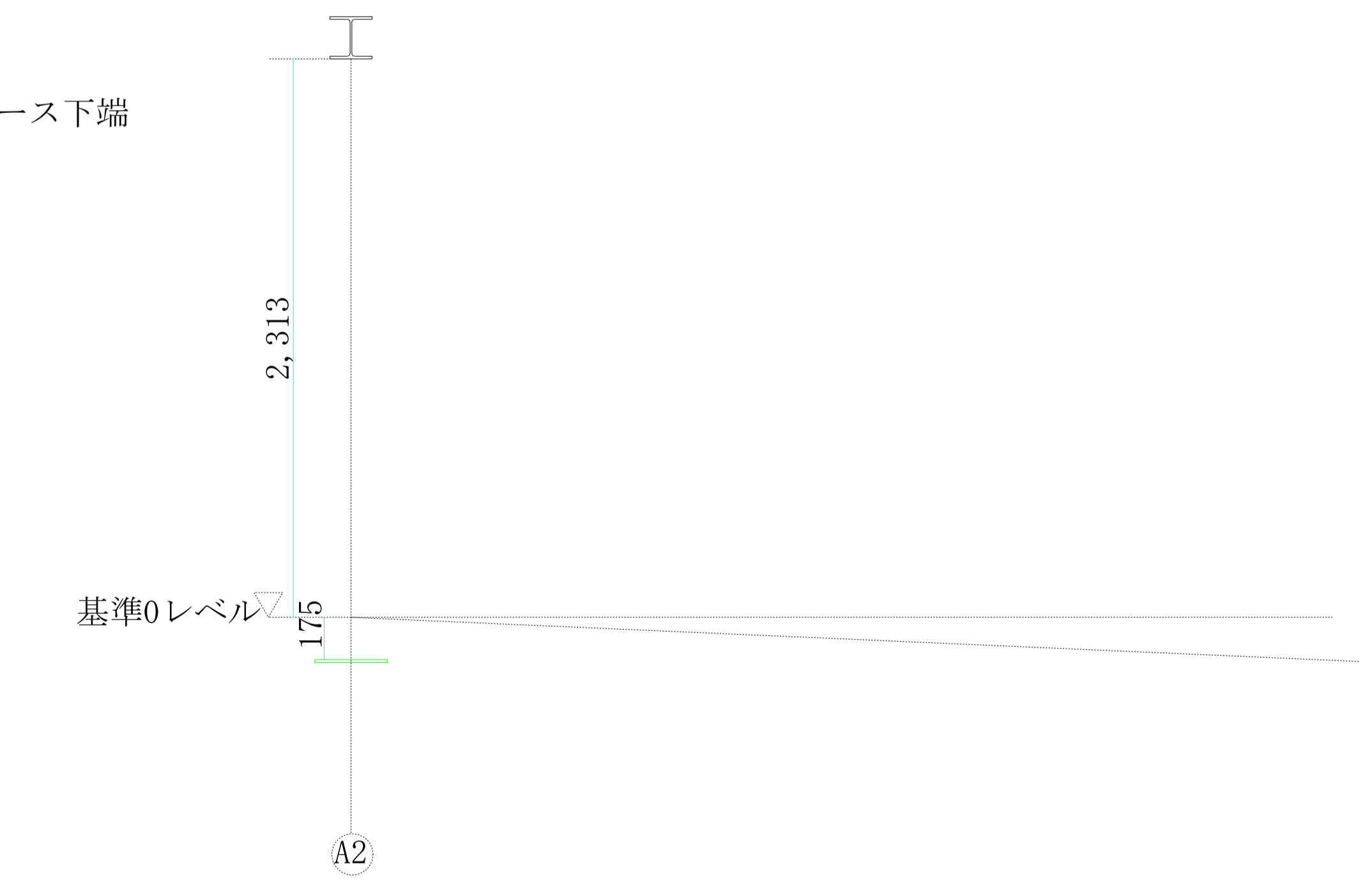

平面図 S=1/20

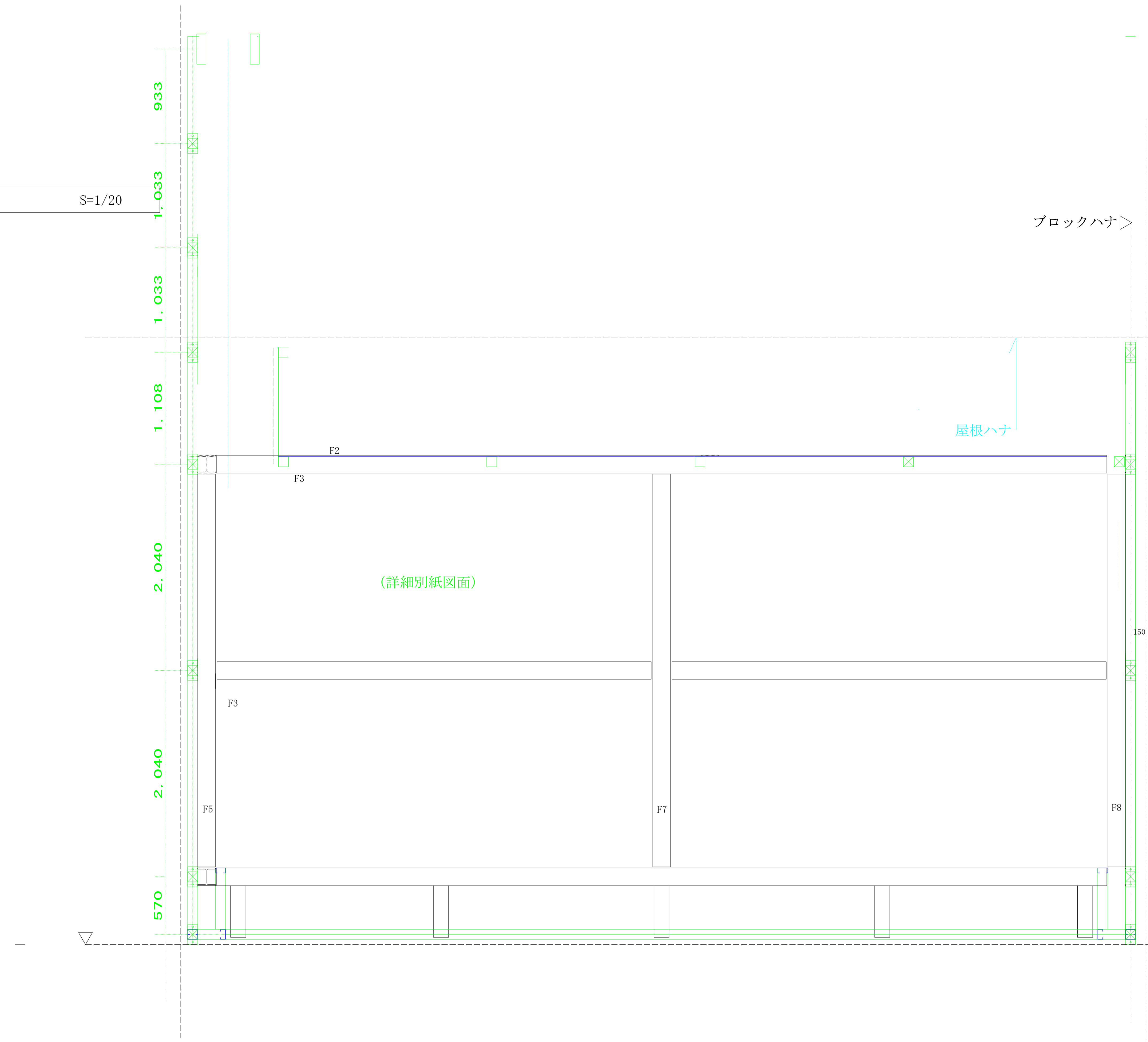

B通り側面 (H外下ジ) S=1/20

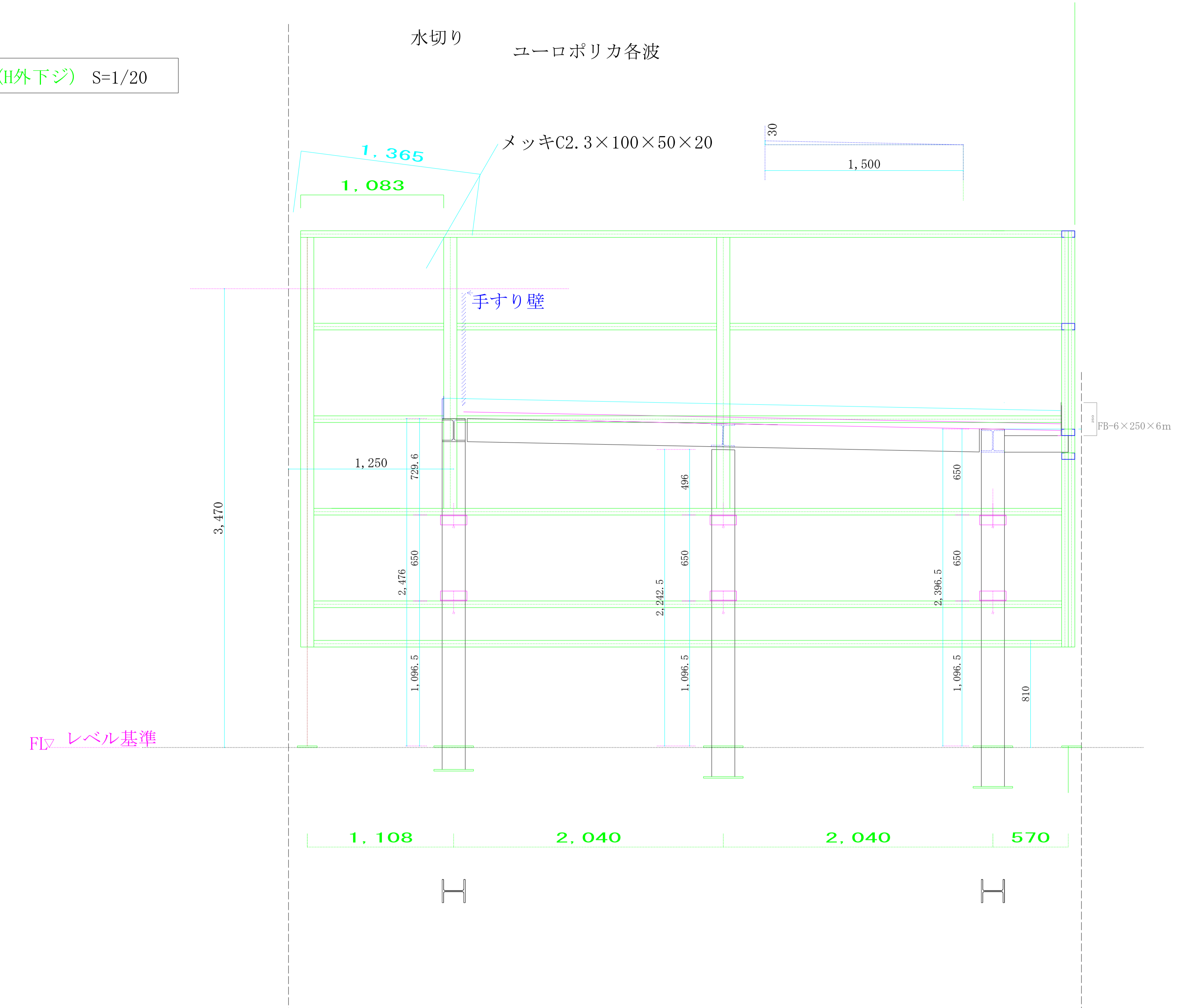

1通り側面 S=1/20

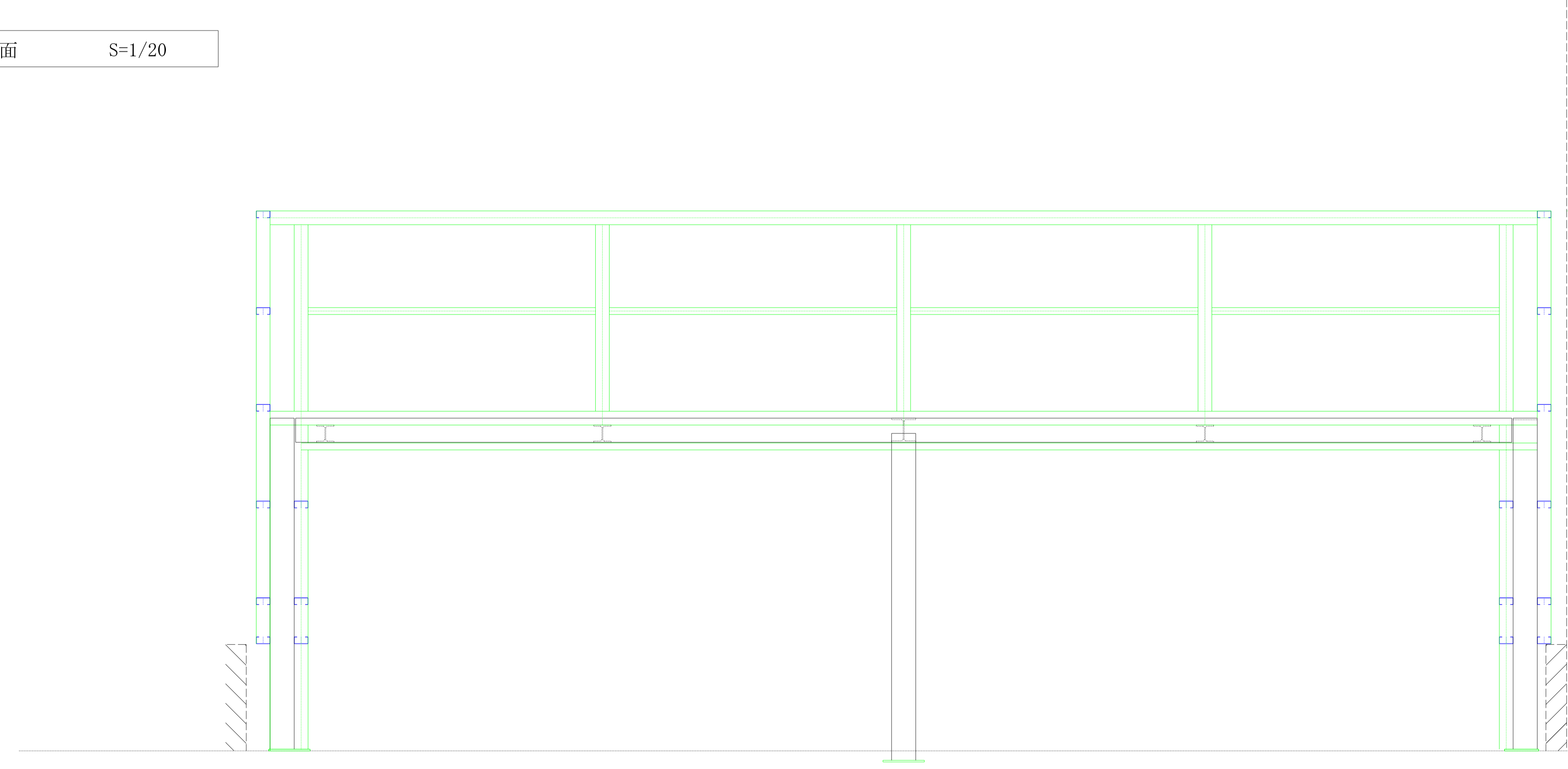

A通り側面 (H外下ジ) S=1/20

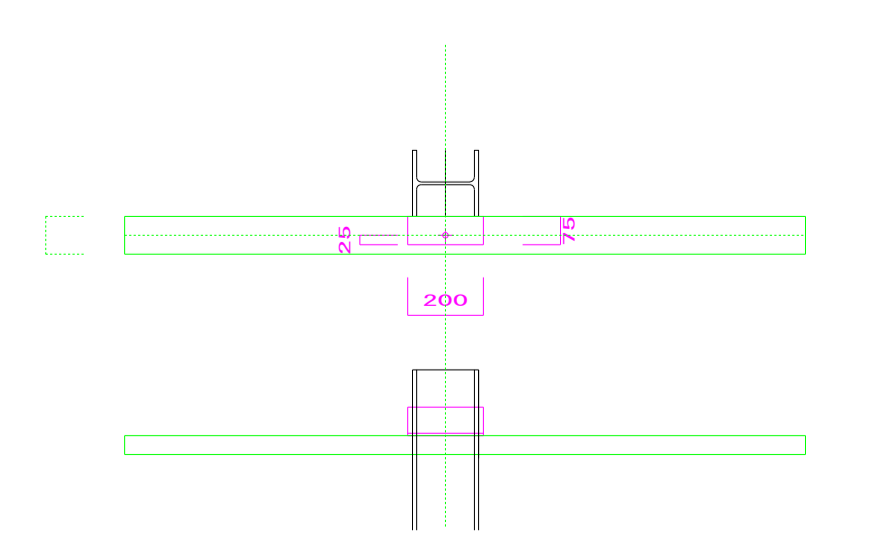
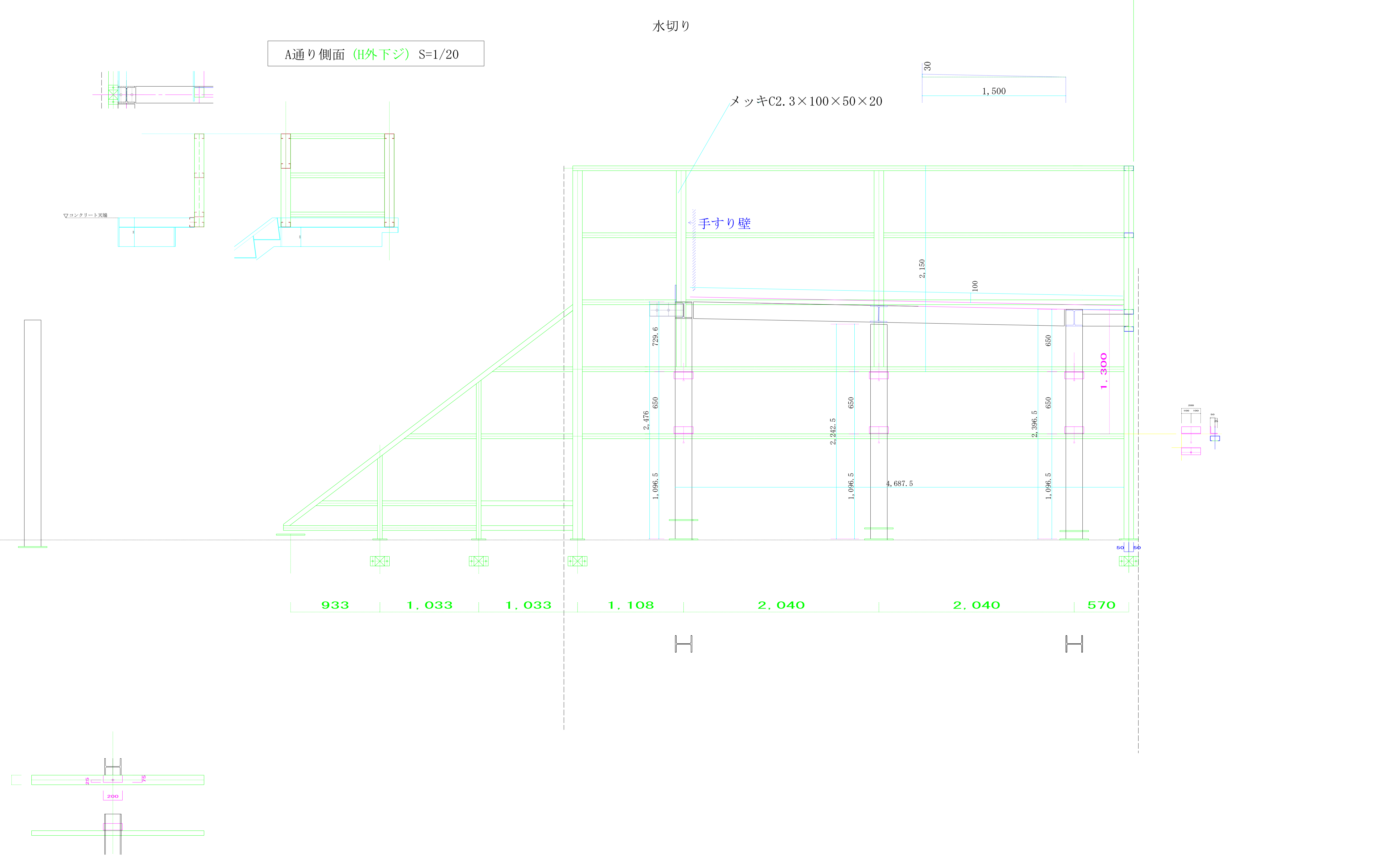

平面図 S=1/20

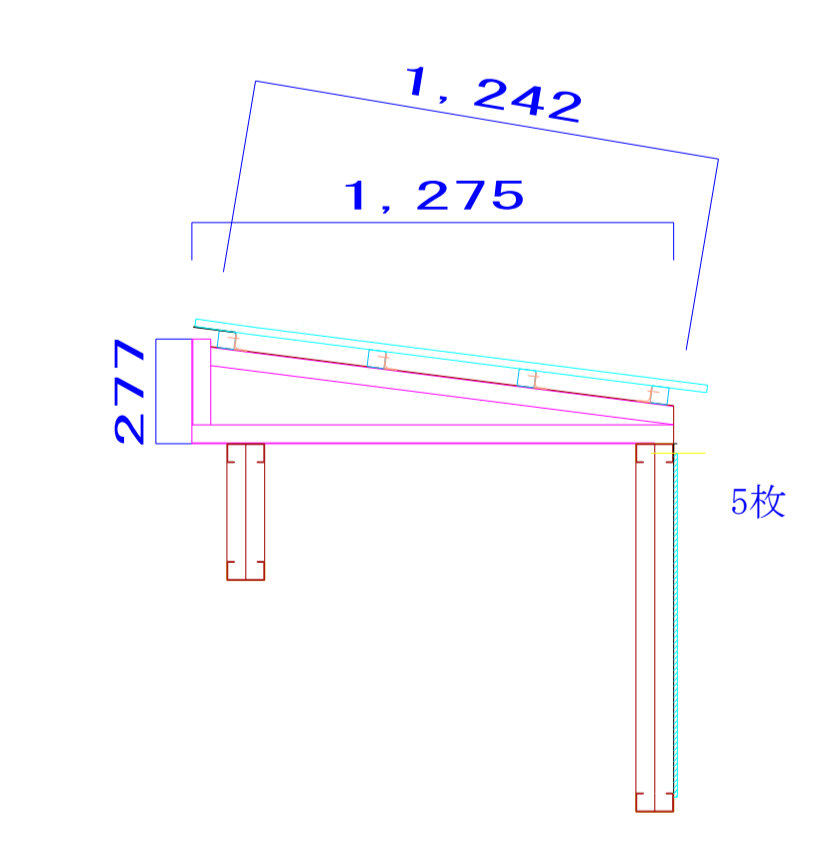
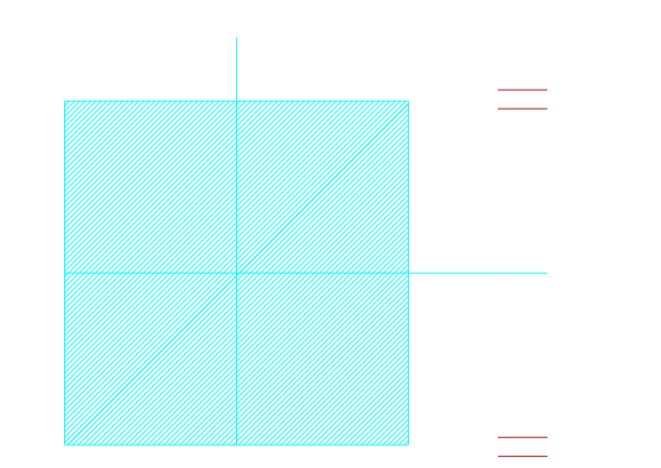
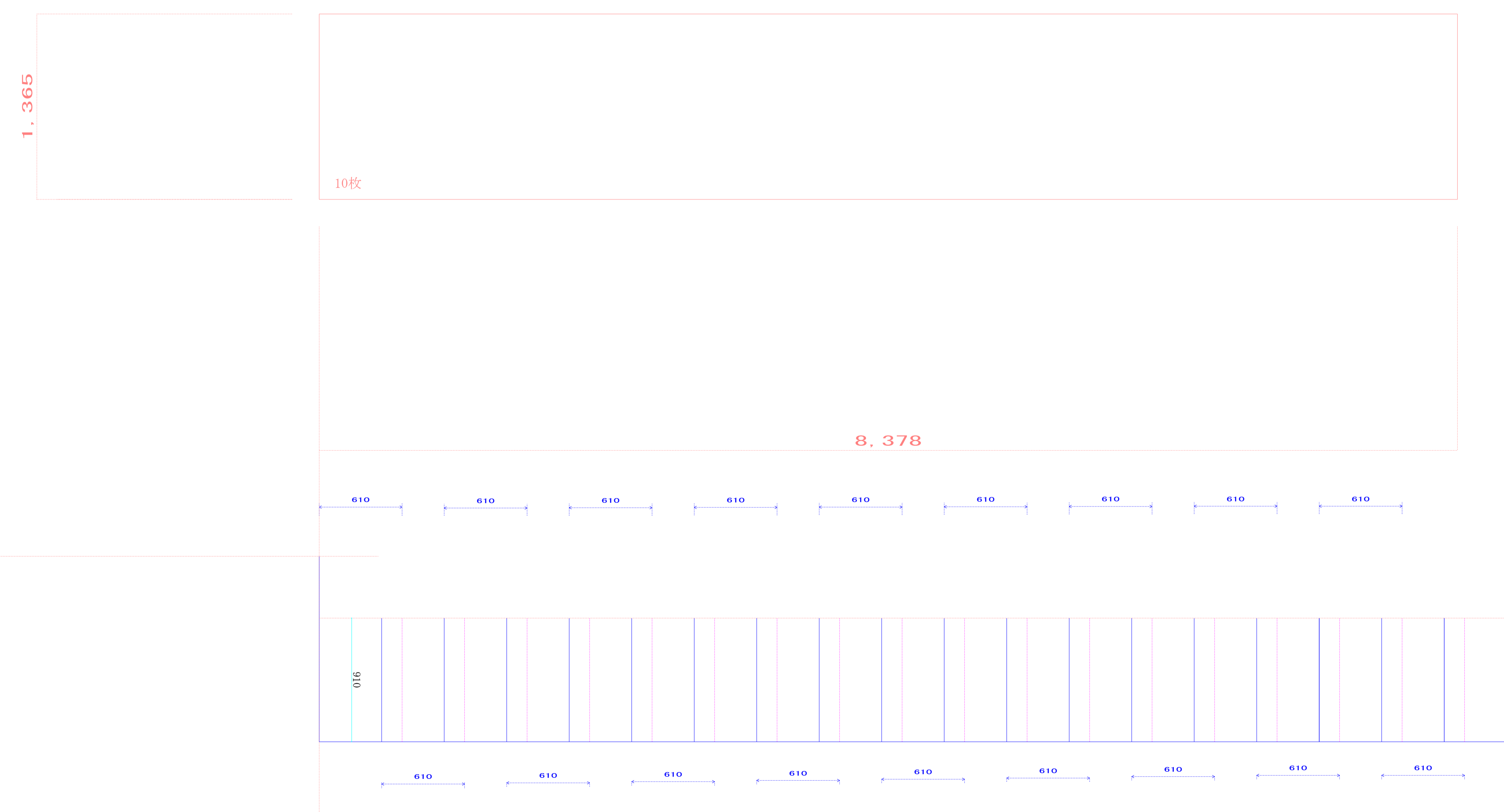
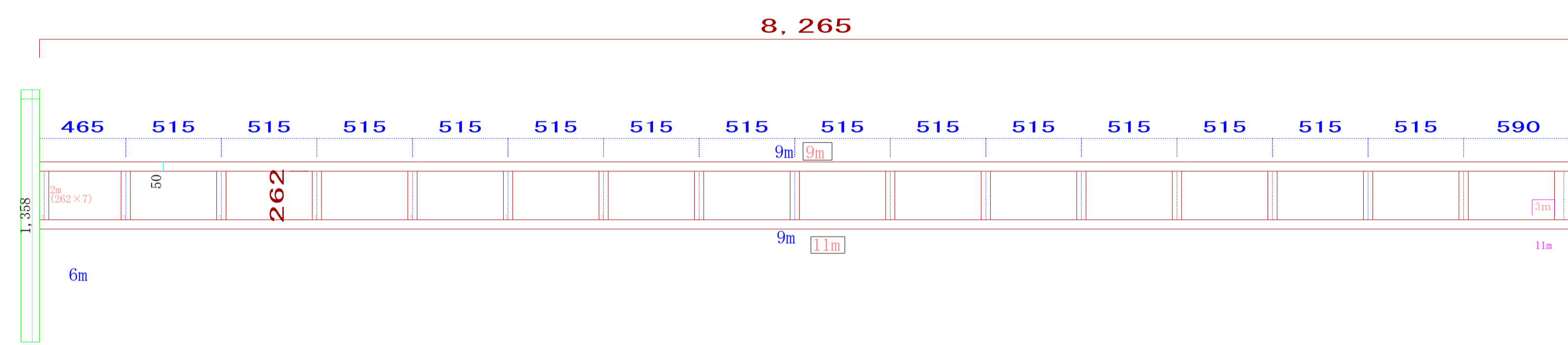
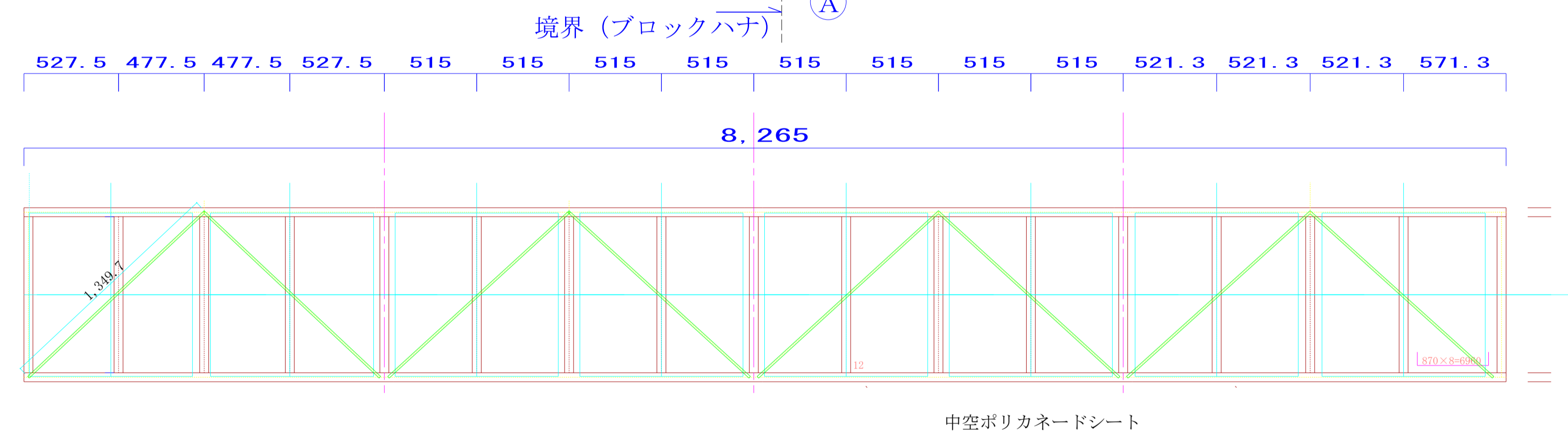
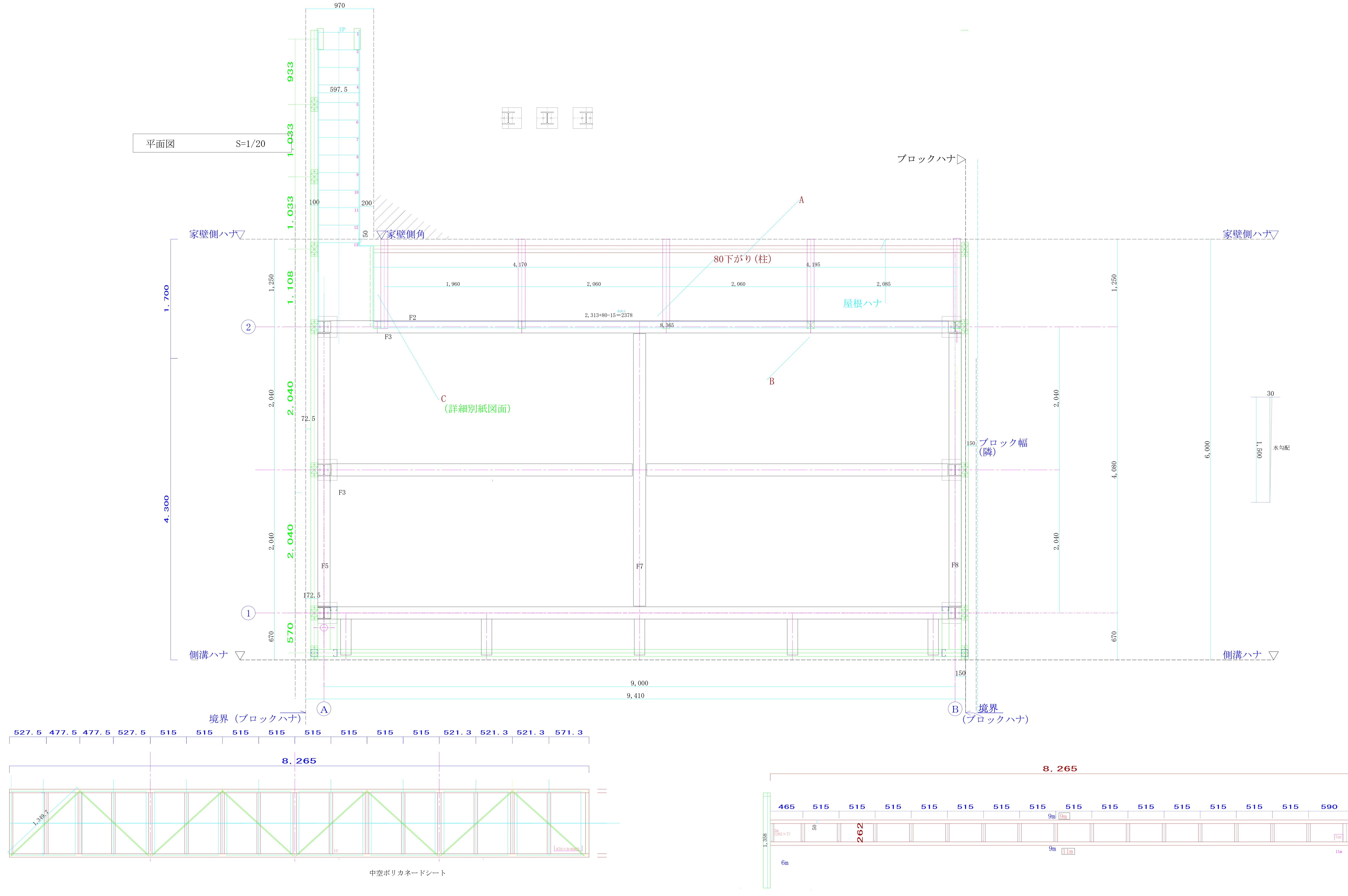

上部  
Cメッキ2.3×100×50×20  
2本 2794 6m 1本 2794×3=8382  
3本 8382 9m 1本 2794×2=5588 12m

下部  
Cメッキ2.3×100×50×20  
後ろ屋根支え6m 1本 9m 1本 11m 1本  
全面手すり 9m 1本 9m 2本 11m 1本 11m 1本

ポリカ角クイタコーロ・ライト 610 クラア  
長さ2,730×幅713 10枚

